



Hypoxia tolerance of European sturgeon (*Acipenser sturio* L., 1758) young stages at two temperatures

By N. Delage^{1,2}, J. Cachot², E. Rochard¹, R. Fraty¹ and P. Jatteau¹

¹Aquatic Ecosystems and Global Changes Research Unit, IRSTEA EABX, Cestas, France; ²University of Bordeaux, UMR CNRS EPOC, Talence, France

Summary

European sturgeon sensitivity to oxygen depletion at two different temperatures was evaluated with embryos from fertilization to hatching time that were exposed to 90% O₂ saturation (% O₂ sat), 50% O₂ sat and 30% O₂ sat at 20 and 26°C; and three-month-old juveniles (12 cm length, 7.3 g width) exposed to oxygen challenge from 70% O₂ sat to 10% O₂ sat at 20 and 25°C. Parameters measured included embryonic survival rate (ESR) and hatch rate (HR); in juveniles the opercular beat frequency (OBF), altered swimming behavior, loss of equilibrium (LOE), and death were recorded. ESR did not differ between oxygen saturation levels for a single temperature but decreased between 20 and 26°C from 60.7 to 21.4% mean survival, respectively. No hatching was observed in embryos exposed to oxygen depletion at 50 and 30% O₂ sat, regardless of temperature. The HR was lower at 26°C (15.4% mean) than at 20°C (75.8%) at 90% O₂ sat. In embryos, all three oxygen concentrations allowed embryonic survival at the tested temperatures but were insufficient for increased activity such as hatching except at 20°C and 90% O₂ sat. In juveniles, OBF peaked at 40% O₂ sat at 212 beats per minute at 25°C and at 40–30% O₂ sat at 182–183 beats per minute at 20°C. For LOE and death no significant differences were observed with regard to oxygen saturation at 20 and 25°C. Altered swimming behavior appeared at a significantly higher oxygen saturation at 25°C (43.5%) compared to 20°C (34.5%). Anaerobic metabolism was initiated after the OBF peak, which would represent a PO₂crit for European sturgeon juveniles under 30 and 40% at 20°C and 25°C, respectively. Temperature increase also adversely affected the threshold of altered swimming behavior, which could be considered as a behavioral indicator of metabolic stress. The probability that the sturgeon embryos are being exposed to harmful temperatures and hypoxic conditions remains a true threat in the Gironde catchment basin.

Introduction

Environmental changes can be critical for the survival of endangered species such as the European sturgeon, *Acipenser sturio*. Although historically present in most large European catchments (Lassalle et al., 2010), *A. sturio* populations decreased dramatically during the 20th century due to human

activities (Lepage et al., 2000; Williot et al., 2002), with only a single wild population remaining in the Gironde Garonne Dordogne (GGD) basin (Williot and Castelnaud, 2011; Williot et al., 2011a). A restoration program was launched with stocking operations managed in the GGD basin. To date more than 1.6 million young fish have been released since 2007 (Acolas et al., 2012). During their downstream migration, juveniles have to cross a maximum turbidity zone (MTZ) where sediment particulate matter exceeds hundreds of g L⁻¹ near the sediment layer (Sottolichio and Castaing, 1999). This high turbidity area temporarily leads to hypoxic conditions on both a diurnal and neap-tide time scale by decreasing the gas exchange between air and water (Abril et al., 2009). Between 1962 and 1994, the MTZ moved upstream (Sottolichio et al., 2013) in response to the decreased river flow.

Mean air surface temperature of the earth rose $0.85 \pm 0.2^\circ\text{C}$ over the period 1880–2012 and according to RCP (Representative Concentrations Pathways) scenarios, projections expect an increase of 1.1–4.8°C by the end of the 21st century (IPCC, 2013). Around 2050, warmer temperatures (between 0.5 and 3.5°C) can be expected in southwestern France, in conjunction with a dryer climate and lower stream flow in summer (Stahl et al., 2010; Sauquet and Catalogne, 2011). As a result, severe hypoxia events are expected to increase in the upstream part of the Gironde estuary (Lanoux et al., 2013). Lassalle et al. (2010) carried out model projections on the effects of increasing temperatures and altered precipitations regarding the suitability of river catchments for sturgeons. The present study was targeted to provide more detailed background data on the tolerance of *A. sturio* embryo-larval and juvenile stages to temperature and oxygen concentrations. The effect of high temperatures has been studied in other sturgeon species (Niklitschek and Secor, 2009; Silvestre et al., 2010; Linares-Casenave et al., 2013), but no study has been carried out on hypoxia tolerance in relation to temperature in sturgeon. Moreover, there are very few studies about tolerance to hypoxic stress in fish from the larval to the juvenile stages (Ishibashi et al., 2005).

Both embryo-larvae and juveniles could be impacted by elevated temperatures and low oxygen levels during their stay in freshwater habitats. The aim of this study was to simulate relevant temperature and hypoxia conditions that embryo-larvae and juveniles could currently encounter in the GGD basin in order to determine stage-sensitivity specificity to these two major environmental parameters. According to the

IPCC (2007), a scenario have been established to simulate putative conditions in the coming years.

Materials and methods

Two distinct protocols were performed, one for embryos and larvae and one for juveniles. Because of its conservation status, *A. sturio* are subjected to regulations minimizing the number of juveniles available for experiments. A behavioral approach was chosen for the experiment, reducing the number of individuals required for comparison in an experiment on survival. On the other hand, prior to total resorption of their yolk sac, embryos and larvae are not covered by the EU regulation on animal testing (2010/63/EU) and can be used in higher numbers for acute toxicity assays.

Biological material

Acipenser sturio embryos (5066 individuals) and juveniles (36 individuals) were obtained from assisted reproductions of the French *ex-situ* broodstock (Williot et al., 2011b). Gametes of two different genetic crosses were collected from spawners after hormonal stimulation (Williot and Chèvre, 2011). In the experiment using juvenile fish, larvae were reared at 18°C and fed *Artemia nauplii* for 3 weeks following hatching and then blood worms until the experiments were carried out.

Embryonic exposure

Oxy-thermal conditions. Temperature and oxygen saturation data for the GGD were provided by the Migado Association (1993–2008) and the Magest consortium (2005–2011) (<http://www.magest.u-bordeaux1.fr>) for stations located upstream and downstream of the sturgeon spawning areas in the Garonne and the Dordogne rivers, respectively.

Embryos used in this study were aged from fertilized eggs (stage 1) to hatched larvae (stage 31), according to Dettlaff et al. (1993). Since embryos depend on cutaneous respiration with low gas exchange due to their limited surface area (Rombough, 1988a), 90% O₂ sat was considered as the acceptable limit to prevent adverse effects on embryos.

Considering the historical reproduction period of the European sturgeon in May and June in this basin (Magnin, 1962), two temperatures (mean and max values observed in the GGD basin) and three oxygen saturation values were selected (90% O₂ sat, min observed 50% O₂ sat, and min predicted considering a 2°C increase in temperature 30% O₂ sat). Altogether, six oxy-thermal conditions were tested (Table 1). Duration of hypoxia was limited to 48 h in order

Table 1

Exposure conditions selected for experiments with European sturgeon (*Acipenser sturio*) larvae and juveniles. Temperature and oxygen saturation combined to obtain six oxy-thermal conditions

	Observed mean	Observed extreme	Scenario
T°C	20°C	26°C	30°C (data not shown)
O ₂ sat	90%	50%	30%

to reproduce events observed in the wild during the sturgeon's incubation period.

Exposure design. An original incubator of 1-L in polyethylene terephthalate glycol-modified was designed for this experiment, with a bottom up water flow through a stainless steel floor grid where the embryos adhered (Fig. 1). Six 45-L buffer tanks of dechlorinated tap water (Fig. 2), corresponding to the six conditions tested, were thermally controlled throughout the experiment using thermistors (Shego 200W, Offenbach am Main, Germany) and chillers (TECO TC10, Ravenna, Italy). Oxygen saturation was maintained by adding O₂ and N₂. Carbon dioxide was used to establish a stable pH at 7.63 ± 0.03 (mean \pm SE). Conditions were established and controlled automatically using a parameter control and recorder unit (SOFREL, S550; LACROIX, Vern sur Seiche, France) and real time data were collected from oxygen and pH probes (respectively, WTW FDO IQ Sensor and WTW SensoLyt 700IQ, WTW, Weilheim, Germany). Temperature and oxygen saturation levels were controlled and recorded every 2 min.

Water was added by peristaltic pumps delivering 34 ml min^{-1} corresponding to two incubator volume renewals

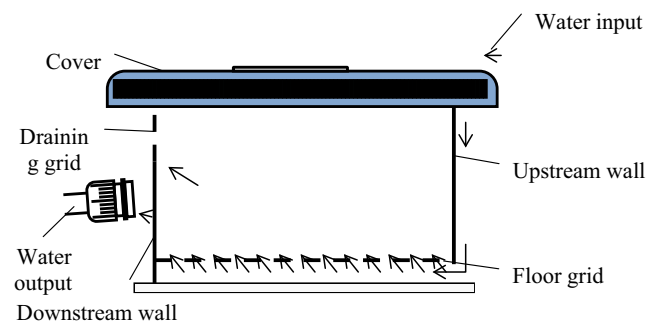

Fig. 1. Incubators for rearing *Acipenser sturio* eggs under desired conditions. Arrows = water flow direction

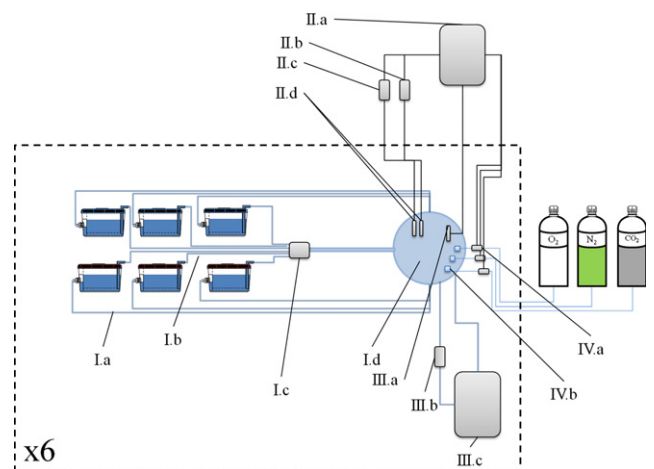

Fig. 2. Exposure system for a single condition, embryo and larvae experiment. I.a: feedback circuit; I.b: supply circuit; I.c: peristaltic pump; I.d: buffer tank. II.a: control and recorder units; II.b: pH meter; II.c: oxymeter; II.d: pH and oxygen probes. III.a: thermistor; III.b: UV lamp; III.c: chiller. IV.a: electrovalve; IV.b: diffusor

per hour. Each buffer tank filled six incubators and outflow was collected in the buffer tank. Every day, 10% of the total volume of each system was replaced.

Experimental procedure. Egg fertilization and handling were performed at 18°C (gamete collection temperature). Immediately after fertilization, each egg batch from a single genetic cross (150 eggs) was placed in an incubator. Because of egg adhesiveness occurring within 4 min after fertilization, eggs were separated from one another before being stuck on the stainless steel grid. During the entire experimentation period a 12h light/12h dark cycle was maintained. Each of the six oxy-thermal conditions was tested in triplicate for each genetic cross (36 batches). Both genetic crosses were tested simultaneously to determine parental effects.

After fertilization, the water temperature was gradually increased at the rate of 1°C per hour to reach the targeted exposure temperature of 20 and 26°C. Embryos were exposed to these temperatures for 15 days. Once the exposure temperature was reached, hypoxia exposure was initiated to reach the targeted O₂ level (30% O₂ sat, 50% O₂ sat and 90% O₂ sat). Hypoxic conditions were maintained from 12 h post-fertilization (hpf) to 60 hpf, then oxygen levels were increased, at a rate of 10% per hour, to reach 90% O₂ sat in all incubators in 4–6 h.

Hatch rate (HR) for each incubator was recorded every 2 h from the first hatching event and up to 12 h after the last one. Dead embryos were counted and removed every day in order to evaluate mortality.

Mortality during the first day of the experiment was not taken into account, because it may have been due to handling and unfertilized oocytes. ESR was calculated by using the number of living larvae for each condition and each genetic cross. HR was evaluated and compared between conditions and between each genetic cross.

Juvenile exposure

The closed system was filled with well-water of constant quality (pH = 7.8; conductivity = 420 µS cm⁻¹). Four 14-L experimental tanks (three hypoxic challenges and one control) were supplied with oxygen and temperature-controlled water (Fig. 3). Temperature and oxygen levels were maintained as described above.

Three-month-old juveniles (Lt 12 ± 0.1 cm – W 7.3 ± 0.3 g) were exposed to a gradually decreasing oxygen level (Fig. 4), following a similar approach to determine the Critical Thermal Limit (CTL) (Becker and Genoway, 1979) and critical swimming speed (U-Crit) (Plaut, 2001; Cai et al., 2013).

Secor and Gunderson (1998) set their normoxic condition to 75% O₂ sat in their study on hypoxia tolerance of juvenile Atlantic sturgeon. In our preliminary test no behavioral modification was observed in juveniles of European sturgeon exposed to 70% O₂ sat for 2 h; this oxygen level was therefore selected as a control level for the juvenile experiment.

Three individuals were introduced into each tank and acclimated for 60 min at 70% O₂ sat while the control tank was maintained at 70% O₂ sat throughout the experiment.

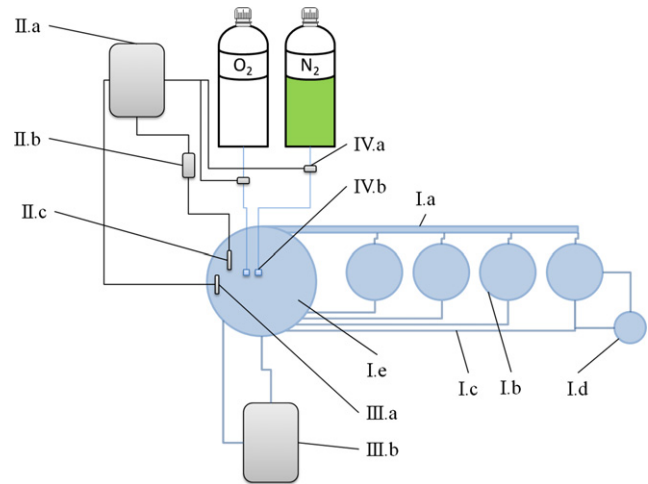

Fig. 3. Exposure system for oxygen challenge in experiments with juveniles. I.a: supply circuit; I.b: experimental tank; I.c: feedback circuit; I.d: regulation tank for control condition; I.e.: water-tower. II.a: control and recorder units; II.b: oxymeter; II.c: oxygen probe. III.a: thermistor; III.b: chiller. IV.a: electrovalve; IV.b: diffuser

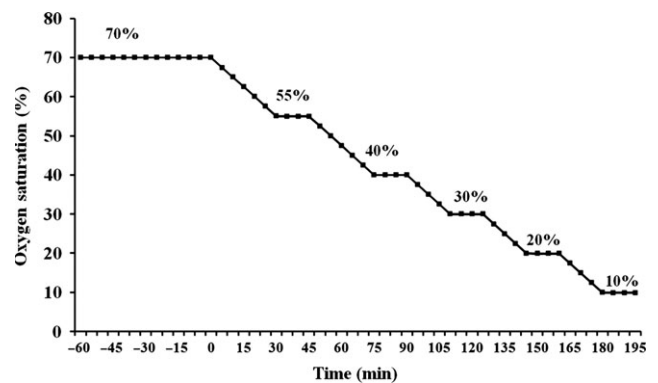

Fig. 4. Decrease in oxygen saturation of rearing water in the closed circuit during the experiment on juveniles

All tanks were hermetically covered to prevent O₂ diffusion via the water surface. An oxygen probe was set in one of the tanks to record dissolved oxygen concentration. Differences were noted towards the end of the experiments where low levels of oxygen were recorded. A time-lag of around 5 min was observed to reach the targeted concentration. Minimum O₂ levels reached were 11 and 12% at 20 and 25°C, respectively.

Three replicated experiments were performed for each temperature tested. Before each experiment, 12 fish were caught from the rearing tank (18°C) and placed in a 30-L aquarium at 20°C for temperature acclimation for 20 min. For the hypoxic test at 20°C, fish were placed directly in the 4 experimental tanks. For tests at 25°C, fish were placed successively in aquaria at 22 and 24°C for 20 min. At the end of the last step, fish were allocated to the 4 tanks at 25°C. Video recordings lasting at least 15 s were made in each tank, during each oxygen level step. Opercular beats were counted from these video recordings for one to two different fish per tank, in order to calculate the opercular beat frequency (OBF).

Response to hypoxia was characterized according to three indicators: altered swimming, loss of equilibrium (LOE), and death. Jerky (erratic) swimming and gulping air at the surface were regarded as visual signs of altered behavior. LOE is an expression of functional and metabolic disturbances, preventing fish from escaping danger (Beitinger et al., 2000). Loss of equilibrium would determine the lower limit of the O₂ level to preserve the likelihood of fish survival. LOE was recorded when fish adopted an oblique swimming position or if they were rolling. Death was recorded when the opercular beats stopped.

Statistics

Statistical analysis was performed using R software Vienna, Austria. Replicated conditions were considered as independent experiments. Data normality was checked using the Shapiro–Wilk test and equality of variance was verified using the Bartlett test. In the case of a normal distribution of data and equality of variance, an analysis of variance was performed (ANOVA) followed by a Tukey *post hoc* test. When one of these criteria was not respected, a non-parametric Kruskal–Wallis test was performed, followed by a Wilcoxon test for the embryo-larval experiment.

Results

Embryonic experiment

Genetic crosses did not show any significant difference in HR (Table 2) independently of exposure conditions (Wilcoxon test, $P = 0.776$). In contrast, a significant difference in survival rate was observed between tested conditions (Wilcoxon test, $P = 0.008$).

Hatching rate (HR). At 30% O₂ sat and 50% O₂ sat, whichever the temperature condition considered, the HR was close to 0%. At 90% O₂ sat there was a drastic decrease in HR between 20 and 26°C (Fig. 5), which collapsed from $75.8 \pm 3.7\%$ at 20°C to $15.4 \pm 4.7\%$ at 26°C. Hatching time 50% at 20°C was 104.5 ± 3.1 hpf and 78.9 ± 3.7 hpf at 26°C. The Wilcoxon test showed a significant difference between conditions ($P < 0.002$).

Embryo survival rate (ESR). For the same oxygen condition, the ESR was lower at 26 than at 20°C (Fig. 6). The Wilcoxon test highlighted that ESR differed significantly according to temperature conditions ($P = 3.4 \times 10^{-7}$). In contrast, no significant difference was observed between the different O₂

conditions, whatever the temperature considered (Wilcoxon test, $P = 0.262$ for 20°C and $P = 0.236$ for 26°C) (Fig. 5).

Juvenile experiments

At the temperatures tested, no change was recorded in OBF in the control tank (Fig. 7) that was maintained at 70% O₂ sat during the course of the experiment (KW, $P > 0.5$). At both temperatures, OBF in fish exposed to hypoxia was significantly different from that of the control fish (KW, $P = 0$) except at 20% O₂ sat for 25°C ($P > 0.05$).

At 25°C at each oxygen stepwise reduction, OBF was higher in both hypoxia (Fig. 7) and control groups compared to the respective groups at 20°C (Mann–Whitney, $P = 0$).

Regardless of temperature, OBF exhibited a similar pattern, increasing significantly with decreasing O₂ levels to 40% O₂ sat, and then significantly decreasing beyond this point (Mann–Whitney *U*-test, $P < 0.05$).

Whatever the temperature, fish in the control tank exhibited no significant modification of their survival and behavior.

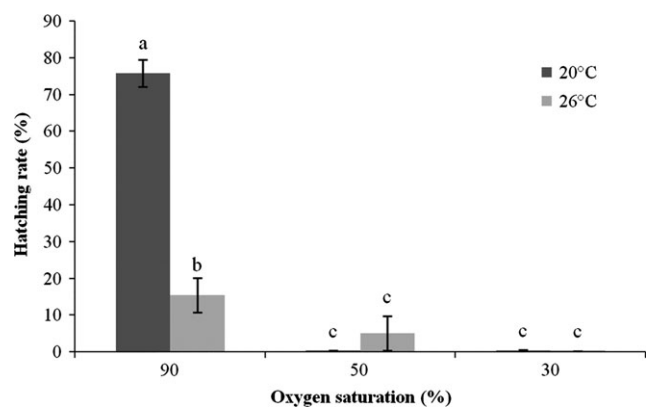

Fig. 5. *Acipenser sturio* Hatching Rate (HR) (mean + SE) of embryos as a function of temperature and oxygen saturation levels. Letters = significant differences between O₂ conditions (KW tests) at same temperature ($n = 6$ replicates per condition)

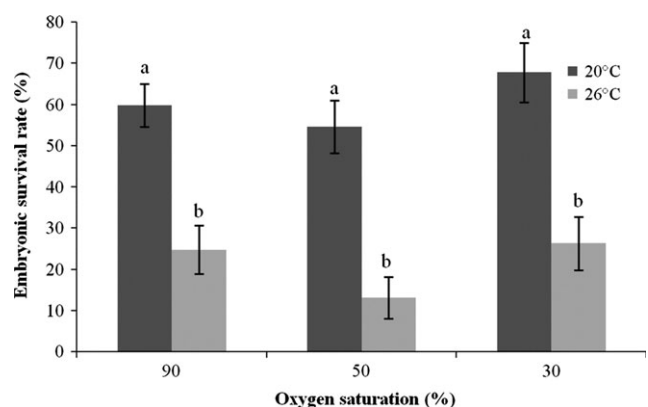

Fig. 6. *Acipenser sturio* Embryonic Survival Rate (ESR) (mean + SE) at 6 dpf as a function of temperature and oxygen saturation levels. Letters = significant differences between O₂ conditions (KW tests) at same temperature ($n = 6$ replicates per condition)

Table 2
Genetic cross effects on larvae hatching and survival

	Cross 1	Cross 2
ESR (%)	30.5 ± 22.7	51.6 ± 22.9
HR (%)	13.4 ± 25.6	18.9 ± 31.6

ESR, embryonic survival rate; HR, hatch rate.

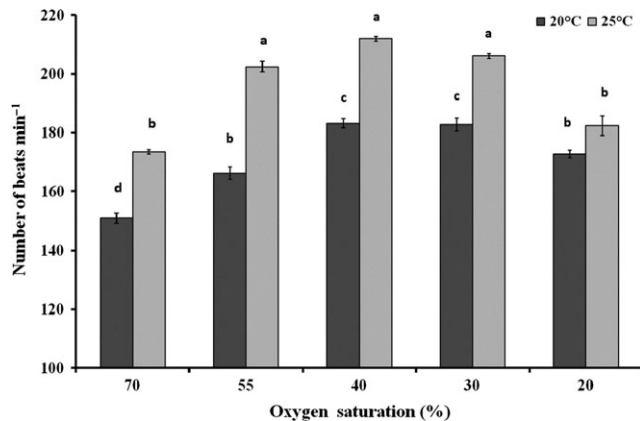

Fig. 7. *Acipenser sturio* Opercular Beat Frequency (OBF) in juveniles ($n = 3$) at 20°C (mean \pm SE) at different levels of oxygen saturation. Letters = significant differences between oxygen saturation steps (Mann–Whitney, $P < 0.05$) or within a temperature experiment (KW, $P < 0.05$)

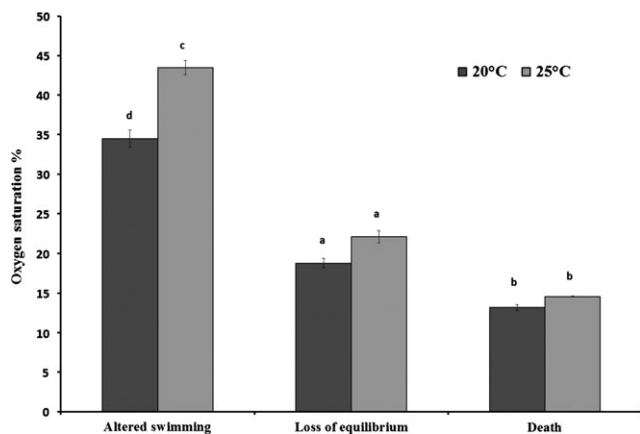

Fig. 8. *Acipenser sturio* threshold of appearance of adverse effects in juveniles according to levels of oxygen saturation and temperature (mean \pm SE). Different letters = significant differences (Mann–Whitney, $P = 0$, $n = 3$)

At 20°C, the first signs of erratic swimming were observed at $34.5 \pm 1.1\%$ O₂ sat (mean \pm SE) compared to $43.5 \pm 0.9\%$ O₂ sat at 25°C (Mann–Whitney, $P = 0$), while no effect of temperature was recorded in the threshold of the appearance of LOE and death (Fig. 8).

LOE appeared at $18.8 \pm 0.6\%$ O₂ sat and $22.1 \pm 0.7\%$ O₂ sat at 20 and 25°C, respectively, and was significantly different for both temperatures from altered swimming and death, which appeared at $13.2 \pm 1.4\%$ O₂ sat and $14.6 \pm 0.2\%$ O₂ sat at 20 and 25°C, respectively (Mann–Whitney, $P = 0$). All surviving fish were fed a few hours after the experiments and no subsequent mortality was recorded.

Discussion

In the context of global change, European sturgeon's young stages will be increasingly exposed to drastic physico-chemical conditions during their fresh water life stage in the

Gironde catchment basin. This leads us to address the tolerance of these stages to temperature and oxygen concentration.

Because of their different life history traits and habitat utilizations, embryonic developmental phases and juveniles are exposed to riverine conditions with high variations in temperatures and oxygen levels, depending upon the location in the river (Abril et al., 1999; Travade and Carry, 2008).

The experimental device used for juveniles does not allow fish to use flight response. Thus the reactions to hypoxia we observed were probably not potentially occurring in the wild, since fish could escape when oxygen saturation is decreasing. Only 36 juveniles were used for this experiment, which only allows proposed hypotheses.

Embryonic phase

Lack of oxygen was reported to be a limiting factor in fish hatching (Rombough, 1988b). In *Acanthopagrus butcheri* exposed to hypoxia during the embryonic stage, no hatching was observed below 30% O₂ sat and with a 100% mortality rate after 72 h exposure below 55% O₂ sat (Hassell et al., 2008). In *Coregonus lavaretus* and *C. albula*, as well as in *Neoceratodus forsteri*, exposure to hypoxia induced precocious hatching (Czerkies et al., 2001; Mueller et al., 2011).

Whichever indicator was considered, an increase in temperature resulted in a negative impact. Early exposure to hypoxia had no immediate impact on embryonic survival but did impair hatching success, and the effect of hypoxia seemed to be delayed. It is interesting to note that at 20 and 26°C, embryonic survival was not impacted by oxygen depletion regardless of the oxygen level applied. It is well known that the embryonic oxygen consumption increases with temperature (Barrionuevo and Burggren, 1999). In *Oncorhynchus mykiss*, an increase in energy expenditure was described during hatching (Ninness et al., 2006). Thus, at 26°C, oxygen concentration is likely insufficient to satisfy oxygen demand during the hatching process.

Juveniles

Considering Critical Thermal Maximum (CTM) between 33 and 35°C (Sardella et al., 2008; Zhang and Kieffer, 2014) and temperature range for optimal growth of different sturgeon species (*A. brevirostrum*, *A. medirostris*, *A. sinensis*) between 20 and 26.2°C (Ziegeweid et al., 2008; Feng et al., 2012), it is reasonable to assume that the two temperatures tested in this study were also within the safety range for *A. sturio* juveniles.

It has been shown here that ventilatory frequency is influenced by temperature, as a result of increased metabolism evidenced by the results of the control group at 20 and 25°C. This phenomenon is widely described (Issartel et al., 2005; Melzner et al., 2006) and off-sets the decrease in oxygen saturation in water to maintain a constant blood PO₂.

The ventilatory frequency increases with the decrease in dissolved oxygen content in water until at a threshold beyond which OBF decreases. This OBF response pattern has already been described in other sturgeon species categorized as

oxyregulator (Ruer et al., 1987; Randall et al., 1992; Maxime et al., 1995; Kieffer et al., 2011). According to Nonnotte et al. (1993), anaerobic metabolism is initiated after the OBF peak, which would set the PO_2 crit for European sturgeon juveniles under 30% O_2 sat and 40% O_2 sat at 20 and 25°C, respectively. Despite differences in the tested temperature range and in the body mass of the fish used, our results are consistent with data published for other sturgeon species (Nonnotte et al., 1993; McKenzie et al., 2007; Kieffer et al., 2011).

Hypoxia tolerance decreases with increasing temperature (see review in Vaquer-Sunyer and Duarte, 2011), but our results did not clearly illustrate this relationship. Increased temperatures had only an effect on the appearance of the altered swimming threshold (erratic swimming, burst and glide), which could be considered as a behavioral indicator of metabolic stress. On the other hand, no temperature influence was recorded for LOE and death thresholds.

Khakimullin (1987) just mentioned LOE as a behavioral consequence of hypoxia, and to our knowledge there is no publication reporting LOE data in Acipenseridae subjected to hypoxia. Similar LOE threshold values have been reported in another acipenseriform fish, *Polyodon spathula* (Aboagye and Allen, 2014) and in Atlantic salmon juveniles (Barnes et al., 2011).

The experimental approach used in this study enabled us to assess hypoxic tolerance in *A. sturio* juveniles using two endpoints – LOE and death – both used because of the few references in the literature dealing with this aspect in sturgeon and more generally in fish. Taking into account the animal welfare and because of the threatened status of sturgeon with a restricted number of individuals for experiments, we can propose to use LOE as a suitable endpoint to qualify hypoxic tolerance in sturgeon juveniles. With these first behavioural results and following a conservative positioning, we can propose a safety threshold for sturgeon juveniles at 35 and 45% O_2 Sat and a vital threshold at 19 and 22% O_2 Sat for 20 and 25°C, respectively.

Conclusions

A rise in temperature had a drastic effect on embryonic survival and hatch rate of *A. sturio*. In juveniles, the effects were not as obvious as in the embryo-larval stage. Temperature had no effect on loss of equilibrium, and caused only a slight change in opercular beat frequency. The tolerance of *A. sturio* juveniles to elevated temperatures (25°C) seems higher than that of embryos.

Even with a moderate hypoxia (50% O_2 sat) during the first 2 days of embryonic development, there was a negative effect on the hatch rate.

Embryo exposures to temperature and oxygen levels resulting from the IPCC forecasts could potentially cause adverse impacts on fish performances and fitness of the fish. Our data indicate that current summer superficial temperatures and oxygen levels in the Gironde-Garonne-Dordogne basin area are a real threat to the native European sturgeon population. With temperatures forecasted to rise and an expected increase in hypoxic events, even for a short-term period, the restoration of *A. sturio* in the Gironde-Garonne-

Dordogne basin is considered to be more difficult than initially expected. Concerning the juveniles, the current maximum turbidity zone with low oxygen contents in the lower river section of the Gironde-Garonne-Dordogne basin does not represent a serious threat. Administrative measures by the Bordeaux urban community to restrict discharges of organic matter into the Gironde-Garonne-Dordogne basin, which causes hypoxic events, should have a significant impact on the establishment of the hypoxic zone (Lanoux et al., 2013), thus limiting its impact on the *A. sturio* juvenile stage.

Acknowledgements

Financial support for this work was given by the Région Aquitaine, ANR (Agence Nationale pour la Recherche). Data were provided by MAGEST (MAGEST, Réseau de surveillance automatisée du système estuarien Garonne - Dordogne - Gironde) and the Migado Association (Association migrateur Garonne Dordogne). This study was carried out in the framework of the Cluster of Excellence (COTE).

References

- Aboagye, D. L.; Allen, P. J., 2014: Metabolic and locomotor responses of juvenile paddlefish *Polyodon spathula* to hypoxia and temperature. *Comp. Biochem. Physiol.* **169**, 51–59.
- Abril, G.; Etcheber, H.; Le Hir, P.; Bassoullet, P.; Boutier, B.; Frankignoulle, M., 1999: Oxic/anoxic oscillations and organic carbon mineralization in an estuarine maximum turbidity zone (The Gironde, France). *Limnol. Oceanogr.* **44**, 1304–1315.
- Abril, G.; Commarieu, M. V.; Sottolichio, A.; Bretel, P.; Guérin, F., 2009: Turbidity limits gas exchange in a large macrotidal estuary. *Estuarine, Coastal and Shelf Science* **83**, 342–348.
- Acolas, M.L.; Rouleau, E.; Le barh, R.; Bigot, J.F.; Ballion, B.; Gesset, C.; Rochard, E. 2012: Suivi de la population d'esturgeons européens. In: Programme de recherche et de conservation de l'esturgeon européen *Acipenser sturio*; bilan scientifique et technique 2011. M. L. Acolas (Ed.). Irstea, Bordeaux, pp. 24–32.
- Barnes, R.; King, H.; Carter, C. G., 2011: Hypoxia tolerance and oxygen regulation in Atlantic salmon, *Salmo salar* from a Tasmanian population. *Aquaculture* **318**, 397–401.
- Barrionuevo, W. R.; Burggren, W. W., 1999: O_2 consumption and heart rate in developing zebrafish (*Danio rerio*): influence of temperature and ambient O_2 . *Regulatory Integrative and Comparative Physiology.* *Am. J. Physiol.* **276**, R505–R513.
- Becker, C. D.; Genoway, R. G., 1979: Evaluation of critical thermal maximum for determining thermal tolerance of freshwater fish. *Environ. Biol. Fishes* **4**, 245–256.
- Beitinger, T. L.; Bennett, W. A.; McCauley, R. W., 2000: Temperature tolerances of North American freshwater fishes exposed to dynamic changes in temperature. *Environ. Biol. Fishes* **58**, 237–275.
- Cai, L.; Taupier, R.; Johnson, D.; Tu, Z.; Liu, G.; Huang, Y., 2013: Swimming capability and swimming behavior of juvenile *Acipenser schrenckii*. Part A: ecological Genetics and Physiology. *J. Exp. Zool.* **319A**, 149–155.
- Czerkies, P.; Brzuzan, P.; Kordalski, K.; Luczynski, M., 2001: Critical partial pressures of oxygen causing precocious hatching in *Coregonus lavaretus* and *C. albula* embryos. *Aquaculture* **196**, 151–158.
- Dettlaff, T.A.; Ginsburg, A.S.; Schmalhausen, O.I., Eds., 1993: Sturgeon Fishes. *Developmental Biology and Aquaculture*. Springer Verlag, Berlin, pp. 218–219.
- Feng, G.; Zhuang, P.; Zhang, L.; Duan, M., 2012: Effects of temperature on oxydative stress biomarkers in juvenile Chinese stur-

- geon (*Acipenser sinensis*) under laboratory conditions. *Adv. Mater. Res.* **343–344**, 497–504.
- Hassell, K. L.; Coutin, P. C.; Nugegoda, D., 2008: Hypoxia, low salinity and lowered temperature reduce embryo survival and hatch rates in black bream *Acanthopagrus butcheri* (Munro, 1949). *J. Fish Biol.* **72**, 1623–1636.
- IPCC, 2007: Climate change 2007: synthesis report. Contribution of working groups I, II and III to the fourth assessment report of the Intergovernmental Panel on Climate Change. Geneva, Switzerland.
- IPCC, 2013: Climate change 2013: The Physical Science Basis. WG1. Contribution to the 5th Assessment Report of the Intergovernmental Panel on Climate Change. Summary for Policymakers, 33p.
- Ishibashi, Y.; Inoue, K.; Nakatsukasa, H.; Ishitani, Y.; Miyashita, S.; Murata, O., 2005: Ontogeny of tolerance to hypoxia and oxygen consumption of larval and juvenile red sea bream, *Pagrus major*. *Aquaculture* **244**, 331–340.
- Issartel, J.; Hervant, F.; Voituron, Y.; Renault, D.; Vernon, P., 2005: Behavioural, ventilatory and respiratory responses of epigeic and hypogean crustaceans to different temperatures. *Comp. Biochem. Physiol., Part A Mol. Integr. Physiol.* **141**, 1–7.
- Khakimullin, A. A., 1987: Oxygen preferendum (preferred oxygen regime) of hatchery young of the Siberian sturgeon, *Acipenser baeri*. *J. Ichthyol.* **27**, 111–115.
- Kieffer, J. D.; Baker, D. W.; Wood, A. M.; Papadopoulos, C. N., 2011: The effects of temperature on the physiological response to low oxygen in Atlantic sturgeon. *Fish Physiol. Biochem.* **37**, 809–819.
- Lanoux, A.; Etcheber, H.; Schmidt, S.; Sottolichio, A.; Chabaud, G.; Richard, M.; Abril, G., 2013: Factors contributing to hypoxia in a highly turbid, macrotidal estuary (the Gironde, France). *Environ. Sci. Process Impacts* **15**, 585–595.
- Lassalle, G.; Crouzet, P.; Gessner, J.; Rochard, E., 2010: Global warming impacts and conservation responses for the critically endangered European Atlantic sturgeon. *Biol. Conserv.* **143**, 2441–2452.
- Lepage, M.; Rochard, E.; Castelnaud, G., 2000: Atlantic sturgeon *Acipenser sturio* L., 1758 restoration and gravel extraction in the Gironde estuary. *Bol. Inst. Esp. Oceanog.* **16**, 175–179.
- Linares-Casenave, J.; Werner, I.; Van Eenennaam, J. P.; Doroshov, S. I., 2013: Temperature stress induces notochord abnormalities and heat shock proteins expression in larval green sturgeon (*Acipenser medirostris* Ayres, 1854). *J. Appl. Ichthyol.* **29**, 958–967.
- Magnin, E., 1962: Recherches sur la systématique et la biologie des Acipenséridés. *Ann. Stat. Cent. Hydrobiol. Appl.* **9**, 7–242.
- Maxime, V.; Nonnotte, G.; Peyraud, C.; Williot, P.; Truchot, J. P., 1995: Circulatory and respiratory effects of an hypoxic stress in the Siberian sturgeon. *Respir. Physiol.* **100**, 203–212.
- McKenzie, D. J.; Steffensen, J. F.; Korsmeyer, K.; Whiteley, N. M.; Bronzi, P.; Taylor, E. W., 2007: Swimming alters responses to hypoxia in the Adriatic sturgeon *Acipenser naccarii*. *J. Fish Biol.* **70**, 651–658.
- Melzner, F.; Bock, C.; Portner, H. O., 2006: Temperature-dependent oxygen extraction from the ventilatory current and the costs of ventilation in the cephalopod *Sepia officinalis*. *J. Comp. Physiol. B.* **176**, 607–621.
- Mueller, C. A.; Joss, J. M. P.; Seymour, R. S., 2011: Effects of environmental oxygen on development and respiration of Australian lungfish (*Neoceratodus forsteri*) embryos. *B: biochemical, Systemic, and Environmental Physiology. J. Comp. Physiol.* **181**, 941–952.
- Niklitschek, E.J.; Secor, D.H., 2009: Dissolved oxygen, temperature and salinity effects on the ecophysiology and survival of juvenile Atlantic sturgeon in estuarine waters: i. Laboratory results. *J. Exp. Mar. Biol. Ecol.* **381**(Suppl.), S150–S160.
- Ninness, M. M.; Stevens, E. D.; Wright, P. A., 2006: Energy expenditure during hatching in rainbow trout (*Oncorhynchus mykiss*) embryos. *Can. J. Fish. Aquat. Sci.* **63**, 1405–1413.
- Nonnotte, G.; Maxime, V.; Truchot, J. P.; Williot, P.; Peyraud, C., 1993: Respiratory responses to progressive ambient hypoxia in the sturgeon, *Acipenser baeri*. *Respir. Physiol.* **91**, 71–82.
- Plaut, I., 2001: Critical swimming speed: its ecological relevance. *Comp. Biochem. Physiol.* **131**, 41–50.
- Randall, D. J.; McKenzie, D. J.; Abrami, G.; Bondiolotti, G. P.; Natiello, F.; Bolis, L.; Agradi, E., 1992: Effect of diet on response to hypoxia in sturgeon (*Acipenser naccarii*). *J. Exp. Biol.* **170**, 113–125.
- Rombough, P. J., 1988a: Growth, aerobic metabolism, and dissolved-oxygen requirements of embryos and alevins of steelhead, *Salmo gairdneri*. *Can. J. Zool.* **66**, 651–660.
- Rombough, P. J., 1988b: 2 Respiratory gas exchange, aerobic metabolism, and effects of hypoxia during early life. *Fish Physiol.* **11**, 59–161.
- Ruer, P. M.; Cech, J. J. Jr; Doroshov, S. I., 1987: Routine metabolism of the white sturgeon, *Acipenser transmontanus*: effect of population density and hypoxia. *Aquaculture* **62**, 45–52.
- Sardella, B. A.; Sanmarti, E.; Kultz, D., 2008: The acute temperature tolerance of green sturgeon (*Acipenser medirostris*) and the effect of environmental salinity. Part A – Ecological Genetics and Physiology. *J. Exp. Zool.* **309A**, 477–483.
- Sauquet, E.; Catalogne, C., 2011: Comparison of catchment grouping methods for flow duration curve estimation at ungauged sites in France. *Hydrol. Earth Syst. Sci.* **15**, 2421–2435.
- Secor, D. H.; Gunderson, T. E., 1998: Effects of hypoxia and temperature on survival, growth and respiration of juvenile Atlantic sturgeon, *Acipenser oxyrinchus*. *Fish. Bull.* **96**, 603–613.
- Silvestre, F.; Linares-Casenave, J.; Doroshov, S. I.; Kultz, D., 2010: A proteomic analysis of green and white sturgeon larvae exposed to heat stress and selenium. *Sci. Total Environ.* **408**, 3176–3188.
- Sottolichio, A.; Castaing, P., 1999: A synthesis on seasonal dynamics of highly-concentrated structures in the Gironde estuary. *Comptes Rendus de l'Académie de Sciences – Serie IIa: Sciences de la Terre et des Planètes* **329**, 795–800.
- Sottolichio, A.; Hanquiez, V.; Périnotto, H.; Sabouraud, L.; Weber, O., 2013: Evaluation of the recent morphological evolution of the Gironde estuary through the use of some preliminary synthetic indicators. *J. Coast. Res.* **65**, 1224–1229.
- Stahl, K.; Hisdal, H.; Hannaford, J.; Tallaksen, L. M.; Van Lanen, H. A. J.; Sauquet, E.; Demuth, S.; Fendekova, M.; Jodar, J., 2010: Streamflow trends in Europe: evidence from a dataset of near-natural catchments. *Hydrol. Earth Syst. Sci.* **14**, 2367–2382.
- Travade, F.; Carry, L., 2008: Effet de la canicule de 2003 sur les poissons migrateurs en Garonne et dordogne - réflexions sur les effets des rejets thermiques de la centrale nucléaire de Golfech sur la Garonne. *Hydroécol. Appl.* **16**, 169–189.
- Vaquer-Sunyer, R.; Duarte, C. M., 2011: Temperature effects on oxygen thresholds for hypoxia in marine benthic organisms. *Glob. Change Biol.* **17**, 1788–1797.
- Williot, P.; Castelnaud, G., 2011: Historic overview of the European sturgeon *Acipenser sturio* in France: surveys, regulations, reasons for the decline, conservation, and analysis. In: *Biology and conservation of the Atlantic European sturgeon Acipenser sturio L., 1758*. P. Williot et al. (Eds). Springer Verlag, Berlin Heidelberg, pp. 285–308.
- Williot, P.; Chèvre, P., 2011: Reproduction of the cultured brood fish. In: *Biology and conservation of the Atlantic European sturgeon Acipenser sturio L., 1758*. P. Williot et al. (Eds). Springer Verlag, Berlin Heidelberg, pp. 439–448.
- Williot, P.; Rouault, T.; Brun, R.; Pelard, M.; Mercier, D., 2002: Status of caught wild spawners and propagation of the endangered sturgeon *Acipenser sturio* in France: a synthesis. *Int. Rev. Hydrobiol.* **87**, 515–524.

- Williot, P.; Rochard, E.; Desse-Berset, N.; Gessner, J.; Kirschbaum, F., 2011a: Brief introduction to sturgeon with a special focus on the European sturgeon, *Acipenser sturio* L. 1758. In: Biology and conservation of the Atlantic European sturgeon *Acipenser sturio* L., 1758. P. Williot et al. (Eds). Springer Verlag, Berlin Heidelberg, pp. 3–12.
- Williot, P.; Rouault, T.; Brun, J.R.; Pelard, M.; Mercier, D.; Jacobs, L.; Kirschbaum, F., 2011b: Building a brood stock of *Acipenser sturio* in France. In: Biology and conservation of the Atlantic European sturgeon *Acipenser sturio* L., 1758. P. Williot, et al. (Eds). Springer Verlag, Berlin Heidelberg, pp. 425–438.
- Zhang, Y.; Kieffer, J. D., 2014: Critical thermal maximum (CT_{max}) and hematology of shortnose sturgeons (*Acipenser brevirostrum*) acclimated to three temperatures. *Can. J. Zool.* **92**, 215–221.
- Ziegeweid, J. R.; Jennings, C. A.; Peterson, D. L., 2008: Thermal maxima for juvenile shortnose sturgeon acclimated to different temperatures. *Environ. Biol. Fishes* **82**, 299–307.
- Author's address:** Nicolas Delage, IRSTEA EABX, Aquatic Ecosystems and Global Changes Research Unit, 50 avenue de Verdun, F-33612 Cestas, France.
E-mail: nicolas.delage@irstea.fr